



# RS3A THRU RS3M

## SURFACE MOUNT FAST RECOVERY RECTIFIER

Reverse Voltage - 50 to 1000 Volts    Forward Current - 3.0 Ampere

### FEATURES

- The plastic package carries Underwriters Laboratory Flammability Classification 94V-0
- For surface mounted applications
- Fast switching for high efficiency
- Low reverse leakage
- Built-in strain relief, ideal for automated placement
- High forward surge current capability
- High temperature soldering guaranteed: 250°C/10 seconds at terminals

### MECHANICAL DATA

**Case:** JEDEC DO-214AB molded plastic body  
**Terminals:** Solder plated, solderable per MIL-STD-750, Method 2026  
**Polarity:** Color band denotes cathode end  
**Mounting Position:** Any  
**Weight:** 0.007 ounce, 0.24grams

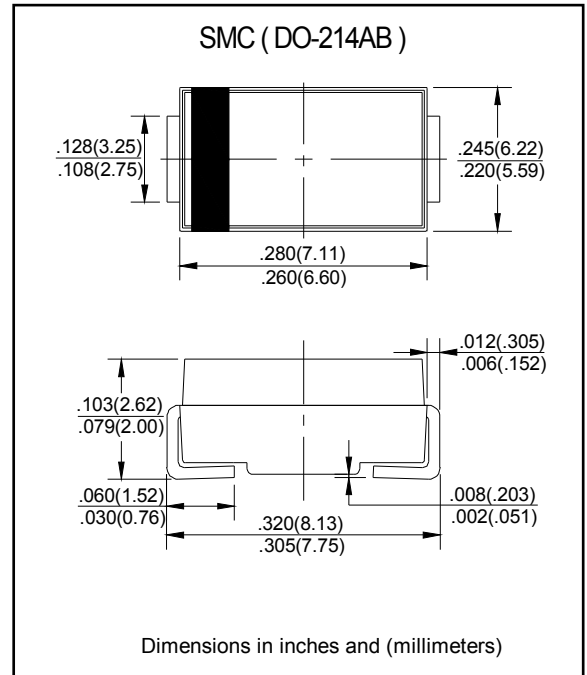

### MAXIMUM RATINGS AND ELECTRICAL CHARACTERISTICS

Ratings at 25°C ambient temperature unless otherwise specified.  
 Single phase half-wave 60Hz, resistive or inductive load, for capacitive load current derate by 20%.

Characteristic	SYMBOLS	RS 3A	RS 3B	RS 3D	RS 3G	RS 3J	RS 3K	RS 3M	UNITS
Maximum repetitive peak reverse voltage	$V_{RRM}$	50	100	200	400	600	800	1000	V
Maximum RMS voltage	$V_{RMS}$	35	70	140	280	420	560	700	V
Maximum DC blocking voltage	$V_{DC}$	50	100	200	400	600	800	1000	V
Maximum average forward rectified current 0.375" (9.5mm) lead length at $T_A=75^\circ\text{C}$	$I_{(AV)}$	3.0							A
Peak forward surge current 8.3ms single half sine-wave superimposed on rated load (JEDEC Method)	$I_{FSM}$	100.0							A
Maximum instantaneous forward voltage at 3.0A	$V_F$	1.3							V
Maximum DC reverse current at rated DC blocking voltage	$I_R$	5.0 250.0							$\mu\text{A}$
Maximum reverse recovery time (NOTE 1)	$t_{rr}$	150			250		500		ns
Typical junction capacitance (NOTE 2)	$C_J$	50.0							pF
Typical thermal resistance (NOTE 3)	$R_{\theta JA}$	20.0							$^\circ\text{C/W}$
Operating junction and storage temperature range	$T_J, T_{STG}$	-65 to +150							$^\circ\text{C}$

**Note:** 1. Reverse recovery condition  $I_F=0.5\text{A}, I_R=1.0\text{A}, I_{rr}=0.25\text{A}$   
 2. Measured at 1MHz and applied reverse voltage of 4.0V D.C.  
 3. P.C.B. mounted with 0.2x0.2" (5.0x5.0mm) copper pad areas



# RS3A THRU RS3M

## RATINGS AND CHARACTERISTIC CURVES

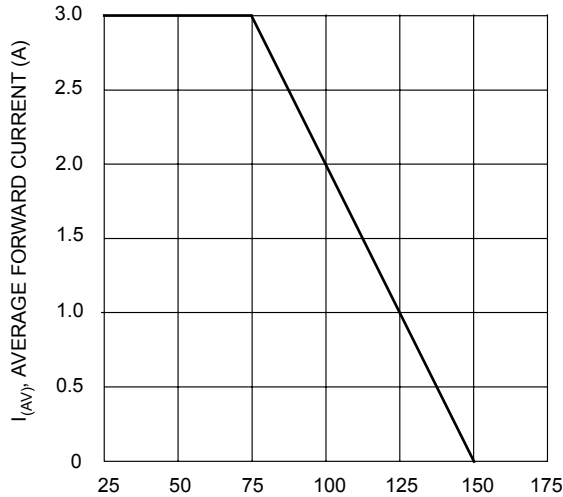

$T_T$ , TERMINAL TEMPERATURE ( $^{\circ}$ C)  
Fig. 1 Forward Current Derating Curve

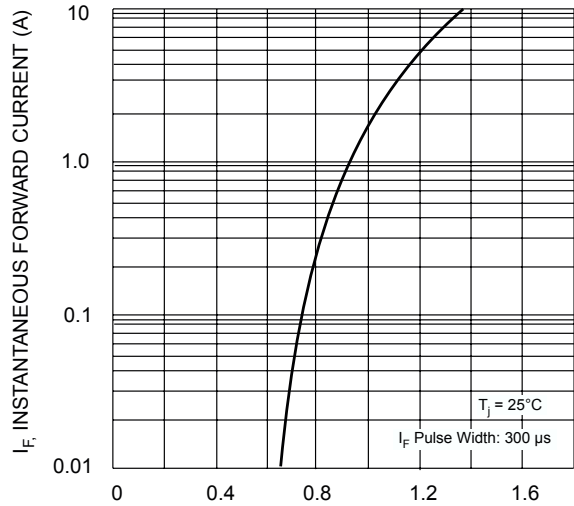

$V_F$ , INSTANTANEOUS FORWARD VOLTAGE (V)  
Fig. 2 Typical Forward Characteristics

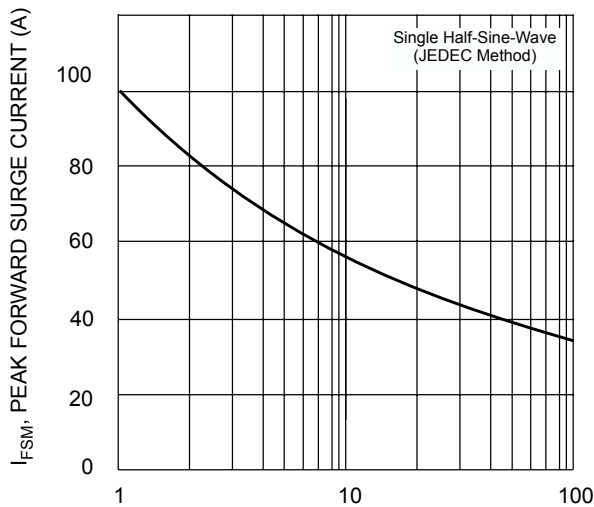

NUMBER OF CYCLES AT 60 Hz  
Fig. 3 Forward Surge Current Derating Curve

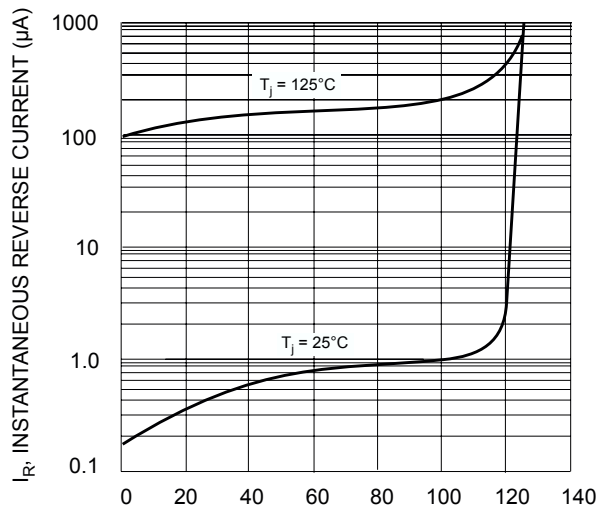

PERCENT OF RATED PEAK REVERSE VOLTAGE (%)  
Fig. 4 Typical Reverse Characteristics

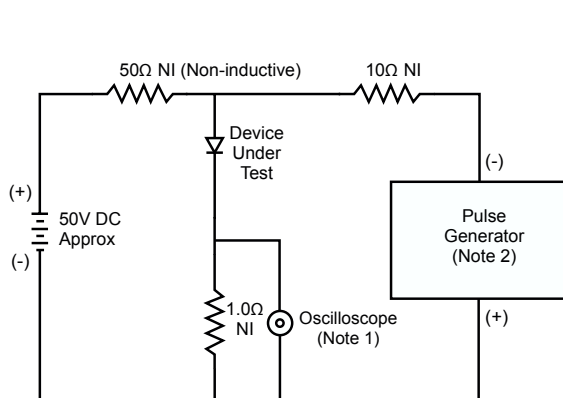

- Notes:  
1. Rise Time = 7.0ns max. Input Impedance = 1.0M $\Omega$ , 22pF.  
2. Rise Time = 10ns max. Input Impedance = 50 $\Omega$ .

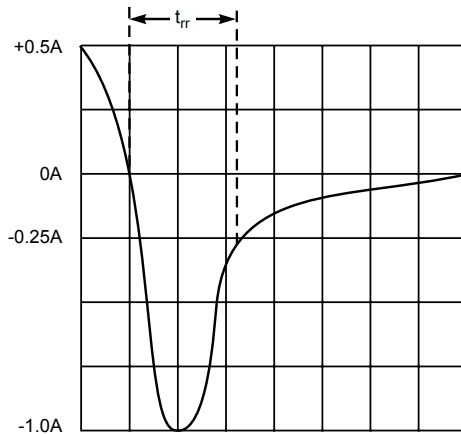

Set time base for 50/100 ns/cm

Fig. 5 Reverse Recovery Time Characteristic and Test Circuit